

LM1-VC12P, LM1-VC12L, LM1-VC36P, LM1-VC36L Volume Controls

www.boschsecurity.com



BOSCH
Invented for life



- ▶ 12 W and 36 W versions
- ▶ Available in Portrait – and Landscape design
- ▶ Suitable for 3-wire and 4-wire override systems
- ▶ Built-in 24 VDC override relay
- ▶ Robust design

Public address systems are often used for both announcements and background music distribution. Volume controls can be used to adjust the sound level locally. In the event of an (emergency) announcement, the built-in relay ensures that the message is broadcast at a preset level, independent of the local volume setting.

The volume controls are suitable for 3-wire and 4-wire override systems.

The volume controls are available in 12 W and 36 W and available in portrait (vertical) and landscape (horizontal) design.

The 12 W volume control features 5 attenuation steps of -3 dB and an off position.

The 36 W volume control features 8 attenuation steps of -3 dB and an off position.

The intuitive graphics around the knob clearly shows the attenuator steps and off position.

Installation/configuration notes

The volume controls can be mounted in standard 2" x 4" electrical installation flush mounting boxes with 2 fixing screws (3 x 15 mm) standard supplied.

The minimum allowable depth of the applied flush mounting box must be 36 mm, allowing convenient wiring.

For the electrical connections, an easy accessible 8-way screw terminal block is provided.

Certifications and approvals

Safety	acc. to EN 60065
Self-extinguishing	acc. to UL 94 V0

DIMENSIONS DRAWINGS

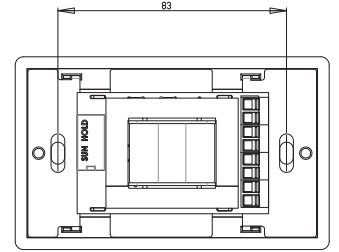
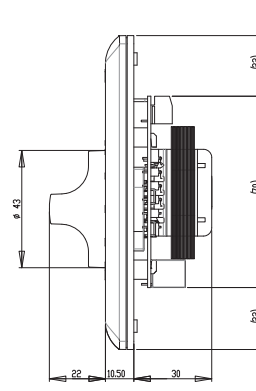
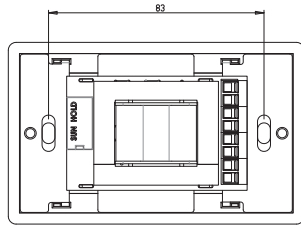
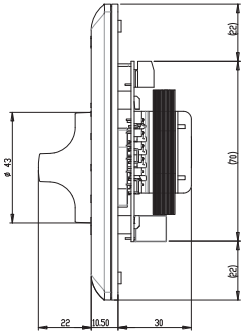
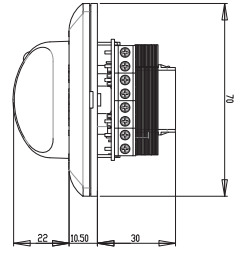
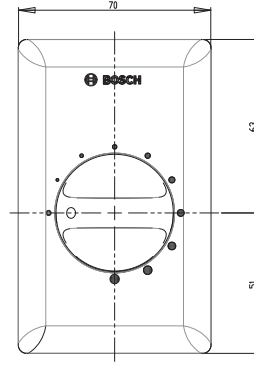
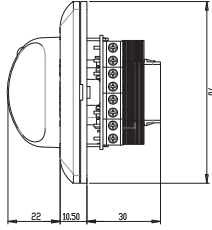
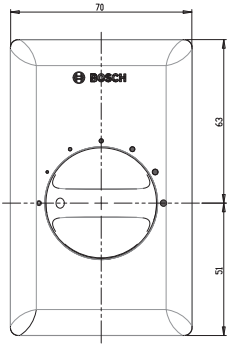

Dimensions LM1-VC12P

Dimensions LM1-VC36P

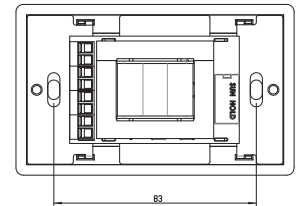
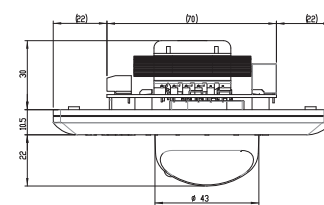
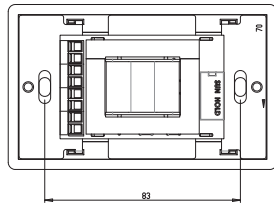
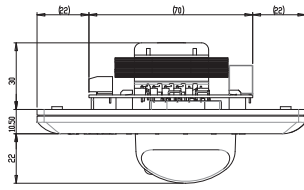
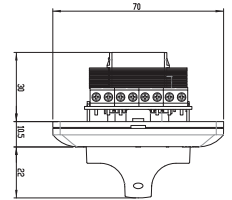
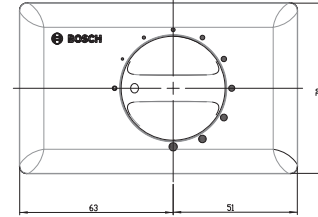
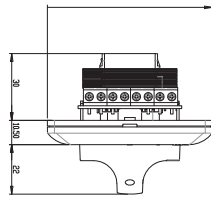
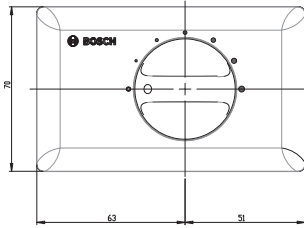

Dimensions LM1-VC12L

Dimensions LM1-VC36L

CIRCUIT DIAGRAMS

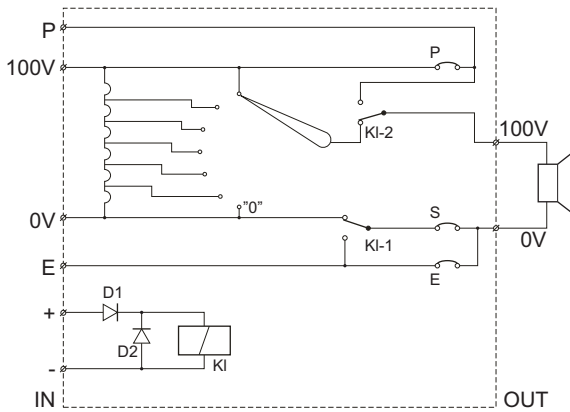

LM1-VC12P/L

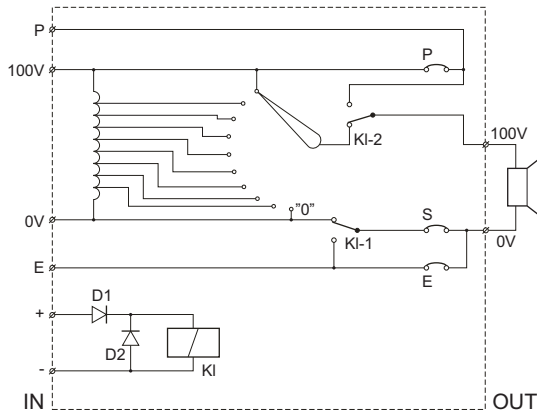

LM1-VC36P/L

Technical specifications

Electrical

LM1-VC12P (portrait version) LM1-VC12L (landscape version)	12 W Volume control
Rated power (PHC)	12 W
Input voltage	100 V
Attenuation steps	5 x -3 dB + off
Max. allowed torque on the switch knob	80 Nm
Frequency response (-1 dB)	50 Hz to 20 kHz
THD	<0.5%
Connection terminal	8-way screw terminal
Acceptable wire gauge ø	0,8 to 1.6 mm
Override relay / Current consumption	20 mA at 24 VDC
LM1-VC36P (portrait version)	36 W Volume control

LM1-VC36L (landscape version)	
Rated power (PHC)	36 W
Input voltage	100 V
Attenuation steps	8 x -3 dB + off
Max. allowed torque on the switch knob	80 Nm
Frequency response (-1 dB)	50 Hz to 20 kHz
THD	<0.5%
Connection terminal	8-way screw terminal
Acceptable wire gauge ø	0,8 to 1.6 mm
Override relay / Current consumption	20 mA at 24 VDC

Mechanical

LM1-VC12P (portrait version) LM1-VC12L (landscape version)	
Dimensions (W x H x D)	114 x 70 x 32 mm
Weight	257 g
Color	White (RAL 9010)
LM1-VC36P (portrait version) LM1-VC36L (landscape version)	
Dimensions (W x H x D)	114 x 70 x 32 mm
Weight	270 g
Color	White (RAL 9010)

Environmental

Operating temperature	-10 °C to +55 °C (14 °F to +131 °F)
Storage temperature	-40 °C to +70 °C (-40 °F to +158 °F)
Relative humidity	<95%

Ordering information

LM1-VC12L Volume Control 12 W (landscape)

Volume control 12 W, Japanese installation type, landscape style, built-in 24 V DC override relay, power-save version, 5 attenuation steps of -3 dB and off, white RAL 9010.

Order number **LM1-VC12L**

LM1-VC12P Volume Control 12 W (portrait)

Volume control 12 W, Japanese installation type, portrait style, built-in 24 V DC override relay, power-save version, 5 attenuation steps of -3 dB and off, white RAL 9010.

Order number **LM1-VC12P**

LM1-VC36L Volume Control 36 W (landscape)

Volume control 36 W, Japanese installation type, landscape style, built-in 24 V DC override relay, power-save version, 8 attenuation steps of -3 dB and off, white RAL 9010.

Order number **LM1-VC36L**

LM1-VC36P Volume Control 36 W (portrait)

Volume control 36 W, Japanese installation type, portrait style, built-in 24 V DC override relay, power-save version, 8 attenuation steps of -3 dB and off, white RAL 9010.

Order number **LM1-VC36P**

Represented by:

Europe, Middle East, Africa:
Bosch Security Systems B.V.
P.O. Box 80002
5600 JB Eindhoven, The Netherlands
Phone: + 31 40 2577 284
emea.securitysystems@bosch.com
emea.boschsecurity.com

Germany:
Bosch Sicherheitssysteme GmbH
Robert-Bosch-Ring 5
85630 Grasbrunn
Germany
www.boschsecurity.com

North America:
Bosch Security Systems, Inc.
130 Perinton Parkway
Fairport, New York, 14450, USA
Phone: +1 800 289 0096
Fax: +1 585 223 9180
onlinehelp@us.bosch.com
www.boschsecurity.us

Asia-Pacific:
Robert Bosch (SEA) Pte Ltd, Security Systems
11 Bishan Street 21
Singapore 573943
Phone: +65 6571 2808
Fax: +65 6571 2699
apr.securitysystems@bosch.com
www.boschsecurity.asia